



KIT DI COLLEGAMENTO A CONTENITORI



KIT FOR CONNECTION TO CONTAINERS
KIT DE RACCORDEMENT DE CONTENEURS

Cod. 0101671	Code	Connection	€	
	0101671.054K0000	In uscita/to exit/ à la sortir	Ø 25 mm	20,63
	0101671.055N0000	In uscita/to exit/ à la sortir	Ø 32 mm	29,00
				
<p>KIT troppo-pieno per IBC: attacco rapido per serbatoio QJ® con innesto dall'esterno e portagomma a compressione curvo BDFast®.</p> <p>IBC OVERFLOW KIT: quick coupling fitting (outside installation) and elbow compression hose nozzle</p> <p>KIT trop-plein pour IBC: raccord rapide pour réservoir QJ® avec insertion de l'extérieur et raccord à compression coude BDFast® pour tuyau</p>				

Cod. 0101672	Code	Connection	€	
	0101672.053I0000	In uscita/to exit/ à la sortir	Ø 20 mm	25,63
				
<p>KIT passaparete per IBC: attacco rapido per serbatoio QJ® con innesto dall'esterno, valvola e portagomma.</p> <p>IBC tank adapter: quick coupling fitting (outside installation) valve and hose nozzle</p> <p>KIT passe-parois pour IBC: raccord rapide pour réservoir QJ® avec insertion de l'extérieur, vanne et raccord pour tuyau.</p>				

Cod. 0101673	Code	Connection	€	
	0101673.054K0000	In uscita/to exit/ à la sortir	Ø 25 mm	29,30
				
<p>KIT passaparete per IBC: attacco rapido per serbatoio QJ® con innesto dall'esterno, valvola e giunto portagomma a compressione BDFast®.</p> <p>IBC tank adapter: quick coupling fitting (outside installation), valve and compression hose nozzle</p> <p>KIT passe-parois pour IBC: raccord rapide pour réservoir QJ® avec insertion de l'extérieur, vanne et raccord à compression BDFast® pour tuyau.</p>				

Cod. 0101674	Code	Connection	€	
	0101674.054M0000	In uscita/to exit/ à la sortir	Ø 30 mm	30,41
				
<p>KIT passaparete per IBC: attacco rapido per serbatoio QJ® con innesto dall'esterno, valvola, portagomma e calotta</p> <p>IBC tank adapter: quick coupling fitting (outside installation), valve, hose nozzle and cap</p> <p>KIT passe-parois pour IBC: raccord rapide pour réservoir QJ® avec insertion de l'extérieur, vanne, raccord pour tuyau et calotte</p>				

Cod. 0101675	Code	Connection	€	
	0101675.05330000	In uscita/to exit/ à la sortir	3/4"	13,80
	0101675.05440000	In uscita/to exit/ à la sortir	1"	14,33
				
<p>KIT passaparete per IBC: attacco rapido per serbatoio QJ® con innesto dall'esterno, calotta e guarnizione piana</p> <p>IBC tank adapter: quick coupling fitting (outside installation) with cap and gasket</p> <p>KIT passe-parois pour IBC: raccord rapide pour réservoir avec insertion de l'extérieur, calotte et joint plat</p>				

Cod. 0101676	Code	Connection	€	
	0101676.0543I000	In uscita/to exit/ à la sortir	Ø 20 mm	27,23
				
<p>KIT passaparete per IBC: attacco rapido per serbatoio QJ® ridotto MF con innesto dall'esterno, valvola e portagomma.</p> <p>IBC tank adapter: reduced quick coupling fitting MF (outside installation), valve and hose nozzle</p> <p>KIT passe-parois pour IBC: raccord rapide pour réservoir QJ® réduit MF avec insertion de l'extérieur, vanne et raccord pour tuyau.</p>				

CARATTERISTICHE GENERALI

Certificazioni
Raccordi per liquidi alimentari*

I raccordi in Poliprene sono compatibili al contatto con i liquidi alimentari secondo il Regolamento UE n.10/2011 e Regolamento CE 1935/2004 per prodotti alimentari acquosi non acidi, compreso acqua potabile in qualsiasi condizione di tempo e temperature inferiori a 40 °C. Materie prime idonee al contatto con acqua potabile e generi alimentari in accordo con il D.M. n.°174 del 06/04/2004

*Contattare i nostri uffici per maggiori informazioni

GENERAL CHARACTERISTIC

Certifications
Fittings for food liquids*

The polypropylene fittings are suitable for contact with food liquids according to UE Directive 10/2011 and EC Directive 1935/2004 for non-acid aqueous food products, including drinking water in any weather condition and at temperatures lower than 40 °C. Raw material suitable for contact with drinking water and foodstuff in accordance with the Ministerial Decree No. 174 of 06/04/2004

*For further information please get in touch with our offices.

CARACTÉRISTIQUES GÉNÉRALES

Certifications
Raccords pour liquides alimentaires*

Conformément au règlement UE 10/2011 et CE 1925/2004 relatifs aux produits alimentaires aqueux non acides, y compris l'eau potable, quelles que soient les conditions météorologiques et à des températures inférieures à 40 °C, les raccords en polypropylène peuvent entrer au contact des liquides alimentaires. Les matières premières appropriées pour le contact avec l'eau potale et denrées alimentaires conformément à l'arrêté ministériel N° 174 du 06/04/2004

*Contacter nos bureaux pour plus d'informations.



BUCCHI S.r.l.
Via Bonsi, 57 - 48022 Lugo - Ravenna - Italy
Tel. +39 0545 901001 r.a. Fax +39 0545 32232
bucchi@bucchi.it - www.bucchi.it

PRODOTTI VERSATILI E KIT

Versatile products and Kit
Produits polyvalents et Kit



LO SVILUPPO CONTINUO
Continuous development
Le développement continuuel

KIT PER CONTENITORI
Kits for containers
Kit pour conteneurs



REV. 38
CATALOGO LISTINO
CATALOGUE PRICE LIST
CATALOGUE LISTE DES PRIX



Fittings for plastic pipes and systems



KIT DI CONNESSIONE PER FUSTI METALLICI- Guarnizione NBR per olio e gasolio

KIT FOR CONNECTION TO METAL DRUMS - NBR gaskets for diesel and oil for engines
KIT DE RACCORDÉMENT POUR FÛTS MÉTALLIQUES - Joint NBR pour huile et gazole

Cod. 0101571	Code	Connection	€
	0101571.0574J000/N	Al serbatoio/to tank/au réservoir	2"
		In uscita/to exit/ à la sortir	Ø 22 mm
			26,11
<p>KIT per FUSTI: adattatore per fusti con guarnizione piana, valvole e portagomma Drums KIT: Tank adaptor with flats gaskets, valve and hose nozzle KIT pour FÛTS: Adaptateur pour fûts avec joint plat, vannes et raccord pour tuyau</p>			

KIT DI CONNESSIONE A CONTENITORE IBC - Guarnizioni EPDM per prodotti chimici



KIT FOR CONNECTION TO IBC CONTAINERS - EPDM gaskets for chemical products
KIT DE RACCORDÉMENT À CONTENEURS IBC - Joints EPDM pour produits chimiques



Cod. 0101563	Code	Connection	€
	0101563.05Z4K000	Al serbatoio/to tank/au réservoir	S60
		In uscita/to exit/ à la sortir	Ø 25 mm
			31,98
<p>KIT per IBC: adattatore per guarnizione piana, valvola e giunto portagomma a compressione BDFast® IBC KIT: adapter with flat gaskets, valve and compression hose nozzle KIT pour IBC: adaptateur avec joint plat, vanne et raccord à compression BDFast® pour tuyau</p>			

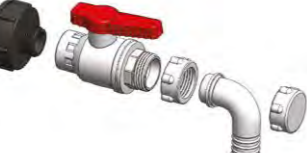

KIT DI CONNESSIONE A CONTENITORE IBC - Guarnizioni EPDM e NBR per acqua



KIT FOR CONNECTION TO IBC CONTAINERS - EPDM and NBR gaskets for water
KIT DE RACCORDÉMENT À CONTENEURS IBC - Joints EPDM et NBR pour eau

Cod. 0101564	Code	Connection	€
	0101564.05Z4M000	Al serbatoio/to tank/au réservoir	S60
		In uscita/to exit/ à la sortir	Ø 30 mm
			32,67
<p>KIT per IBC: adattatore con guarnizione piana, valvola, portagomma e calotta IBC KIT: adapter with flat gaskets, valve, hose nozzle and cap KIT pour IBC: adaptateur avec joint plat, vanne, raccord pour tuyau et calotte</p>			

Cod. 0101567	Code	Connection	€
	0101567.L1204K00	Al serbatoio/to tank/au réservoir	S60
		In uscita/to exit/ à la sortir	1"
			71,96
<p>KIT per tubo flessibile: da 25 mm per la giunzione dei contenitori, due giunti portagomma a compressione BDFast® e valvola IBC KIT: two adapters with flat gaskets, 25 mm flexible hose to joint containers and valve KIT pour flexible: de 25 mm pour le raccordement des conteneurs, deux raccords à compression BDFast® pour tuyau et vanne</p>			



Cod. 0101596	Code	Connection	€
	0101596.L0604KZ0	Al serbatoio/to tank/au réservoir	S60
		In uscita/to exit/ à la sortir	1"
			65,71
<p>IBC in batteria, kit componibili: Adattatori S 60x6 - 1" con guarnizione piana KIT per primo IBC: tubo spiralato 25 mm per unire due giunti a compressione BDFast®, raccordo a T, tappo e due valvole. Kit da utilizzare assieme al mod. 0101597 IBC array, modular kits: Adapter S 60x6 - 1" M with flat gasket. Kit for the first IBC: 25mm spiral hose to connect two BDFast® compression fittings, Tee fitting, two valves and cap. Kit to be used with mod.0101597 Batterie d'IBC, kit modulaires: Adaptateurs S 60x6 - 1" M avec joint plat. KIT pour premier IBC : tuyau spiralé 25 mm pour relier les deux raccords à compression BDFast® pour tuyau, raccord en T, bouchon à double vanne. KIT à utiliser avec le mod. 0101597</p>			

Cod. 0101597	Code	Connection	€
	0101597.L0604KZ0	Al serbatoio/to tank/au réservoir	S60
		In uscita/to exit/ à la sortir	1"
			49,02
<p>IBC in batteria, kit componibili: Adattatori S 60x6 - 1" M con guarnizione piana KIT per ogni IBC aggiuntivo al primo: tubo spiralato 25 mm per unire due giunti a compressione BDFast®, raccordo a T, tappo e valvola. Kit da utilizzare assieme al mod. 0101596 IBC array, modular kits: Adapter S 60x6 - 1" M with flat gasket. Kit for each additional IBC: 25mm spiral hose to connect two BDFast® compression fittings, Tee fitting, valve and cap. Kit to be used with mod.0101596 Batterie d'IBC, kit modulaires: Adaptateurs S 60x6 - 1" M avec joint plat. KIT pour chaque IBC supplémentaire: tuyau spiralé 25 mm pour relier les deux raccords à compression BDFast® pour tuyau, raccord en T, bouchon et vanne. Kit à utiliser avec le mod. 0101596</p>			



Cod. 0101665	Code	Connection	€
	0101665.05Z3I000	Al serbatoio/to tank/au réservoir	S60
		In uscita/to exit/ à la sortir	Ø 20 mm
			72,79
<p>KIT per IBC: due adattatori con guarnizioni piane, raccordi e tubi rigidi filettati per la connessione dei contenitori, valvola (dove è possibile collegare il raccordo rapido per giardinaggio) e portagomma. IBC KIT: two adapters with flat gaskets, fittings, three threaded pipes to joint containers, valve and hose nozzle where it is possible the junction with quick connector for gardening KIT pour IBC: deux adaptateurs avec joints plats, raccords et tuyaux rigides filetés pour le raccordement des conteneurs, vanne (si possibilité de connecter le raccord rapide pour le jardinage) et raccord pour tuyau.</p>			

Cod. 0101666	Code	Connection	€
	0101666.05Z3I000	Al serbatoio/to tank/au réservoir	S60
		In uscita/to exit/ à la sortir	Ø 20 mm
			59,04
<p>KIT per IBC: adattatore con guarnizione piana, raccordi e tubi filettati, due valvole (dove è possibile connettere l'attacco rapido per giardinaggio) e portagomma. IBC KIT: adapter with flat gaskets, fittings, two threaded pipes, two valves (where it is possible the junction with quick connector for gardening) and hose nozzle KIT pour IBC: adaptateur avec joint plat, raccords et tubes filetés, deux vannes (si possibilité de connecter le raccord rapide pour le jardinage) et raccord pour tuyau.</p>			

Cod. 0101667	Code	Connection	€
	0101667.05Z3I000	Al serbatoio/to tank/au réservoir	S60
		In uscita/to exit/ à la sortir	Ø 20 mm
			45,08
<p>KIT per IBC: adattatore con guarnizione piana, raccordi e tubi filettati, valvola (dove è possibile connettere l'attacco rapido per giardinaggio) e portagomma. IBC KIT: adapter with flat gaskets, fittings, two threaded pipes, valve (where it is possible the junction with quick connector for gardening) and hose nozzle KIT pour IBC: adaptateur avec joint plat, raccords et tubes filetés, vanne (si possibilité de connecter le raccord rapide pour le jardinage) et raccord pour tuyau.</p>			

Cod. 0101668	Code	Connection	€
	0101668.05Z3K000	Al serbatoio/to tank/au réservoir	S60
		In uscita/to exit/ à la sortir	Ø 25 mm
			52,02
<p>KIT per IBC: adattatore con guarnizione piana, tubo flessibile e due giunti portagomma a compressione BDFast®. IBC KIT: adapter with flat gaskets, two compression hose nozzles, flexible hose and valve KIT pour IBC: adaptateur avec joint plat, rallonge fileté, vanne et deux raccords à compression BDFast® pour tuyau.</p>			

Cod. 0101669	Code	Connection	€
	0101669.05Z3I000	Al serbatoio/to tank/au réservoir	S60
		In uscita/to exit/ à la sortir	Ø 20 mm
			32,00
<p>KIT per IBC: adattatore con guarnizione piana, prolunga filettata, valvola e portagomma. IBC KIT: adapter with flat gaskets, threaded pipe, hose nozzle and valve KIT pour IBC: adaptateur avec joint plat, rallonge fileté, vanne et raccord pour tuyau.</p>			

Cod. 0101670	Code	Connection	€
	0101670.05Z4K000	Al serbatoio/to tank/au réservoir	S60
		In uscita/to exit/ à la sortir	Ø 25 mm / 1"
			114,59
<p>KIT per IBC: adattatori con guarnizioni piane, tubo flessibile per connettere i due contenitori, raccordi e tubi filettati, giunti portagomma a compressione BDFast®, portagomma e valvole (dove è possibile connettere l'attacco rapido per giardinaggio) IBC KIT: adapter with flat gaskets, fittings, two compression hose nozzles, flexible hose to joint horizontal or vertical containers, threaded pipes, valves where it is possible the junction with quick connector for gardening and hose nozzles KIT pour IBC: adaptateurs avec joints plats, flexible pour raccorder les deux conteneurs, raccords et tubes filetés, raccords à compression BDFast® pour tuyau, raccord pour tuyau et vanne (si possibilité de connecter le raccord rapide pour le jardinage).</p>			